



# Trabecular Metal™ Modular Acetabular System

Surgical Technique



The Best Thing Next to Bone™



<b>Trabecular Metal Modular Acetabular System Surgical Technique</b>	<b>Table of Contents</b>	
	<b>Acetabular Reaming</b>	<b>2</b>
	<b>Component Sizing</b>	<b>2</b>
	<b>Provisional Shell Positioning and Alignment</b>	<b>3</b>
	<b>Provisional Liner and Trial Range of Motion</b>	<b>3</b>
	<b>Positioner Assembly</b>	<b>4</b>
	<b>Implant Positioning and Alignment</b>	<b>4</b>
	<b>Implant Orientation</b>	<b>5</b>
	<b>Implant Insertion</b>	<b>5</b>
	<b>Screw Insertion</b>	<b>6</b>
	<b>Liner Positioning</b>	<b>6</b>
	<b>Liner Insertion</b>	<b>7</b>
	<b>Locking Ring Replacement (if required)</b>	<b>7</b>
	<b>Final Reduction</b>	<b>8</b>
	<b>Ordering Information</b>	<b>9</b>

## Acetabular Reaming

Use reamer to prepare acetabular implant site. Hold reamer steady and apply pressure in the same direction that the prosthesis will be implanted.



## Component Sizing

Provisional shell sizes match the outside dimensions of the acetabular reamers. The elliptical *Trabecular Metal* Modular Acetabular Cup provides 2mm of interference fit at its periphery if the labeled cup size matches the last reamer size used. For example, the 54mm acetabular cup has an outer diameter of 56mm at its rim, but matches the height of the reaming at the polar dome of the cup.

**Note: The amount of press fit used should be determined at time of surgery and be based upon bone quality.**

Select the provisional shell that is the same size as the last even-numbered reamer used. Thread the provisional shell onto the positioner securely. Impact the alignment connector to engage onto the taper. Tighten Locking Nut.

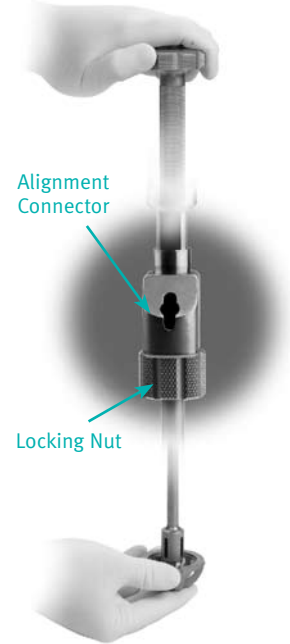

Alignment Connector

Locking Nut



Optional MIS Offset Reamer Handle  
00-7804-080-00

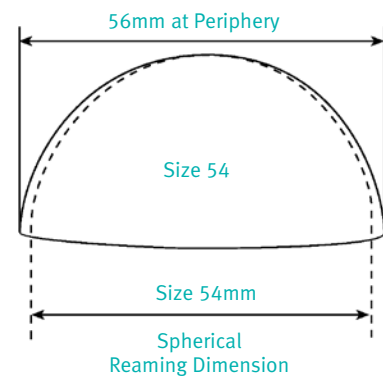

## Provisional Shell Positioning and Alignment

Ensure the patient is in the correct position. With the Provisional Shell connected to the positioner, insert the Provisional Shell into the prepared site. Keep the slaphammer portion of the positioner vertical, and “A-Frame” or “Gunsight” extension parallel with the patient’s body, to achieve 45 degrees abduction and 20 degrees forward flexion.

**Note: The Provisional Shell has protruding, 1mm teeth around the rim for stability during trial reduction. It also has fenestrations so that cup seating can be assessed.**

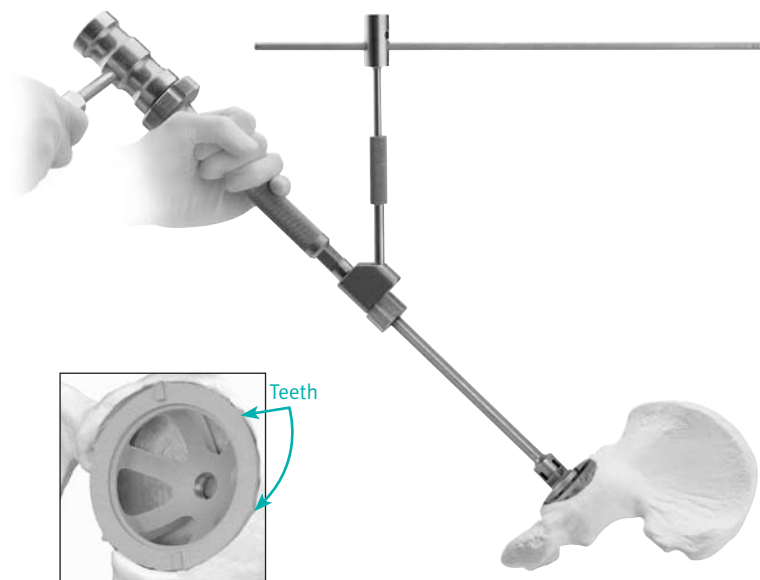

## Provisional Liner and Trial Range of Motion

Select the Provisional Liner size that matches the previously selected Provisional Shell. Perform trial reduction. After determining the appropriate style, face angle, and position, mark the bone opposite the positioning mark on the liner. This mark serves as a reference later when positioning the Acetabular Cup.

*Optional: The Provisional Liner Polar Screw can be used to lock the Provisional Liner and Provisional Shell together during trial reduction.*

**Warning: Do not impact onto the Provisional Liner as damage may occur.**



Provisional Liner and Shell

## Positioner Assembly

Thread the implant onto the positioner securely. Position alignment connector as shown. Alignment connector should be in line with locking ring access. Impact alignment connector to engage onto the taper. Tighten Locking Nut. Impaction will be applied primarily to the dome of the implant.

*Alternatively: The Rim Impactor can be utilized. Remove the cap from the Cup Positioner and replace with the Rim Impactor. The Rim Impactor size should correspond with the implant size selected. The implant should be threaded onto the positioner securely. Impaction will be applied primarily to the rim of the implant.*

**Warning: Use caution to avoid impacting the anti-rotational tabs on the rim of the implant.**

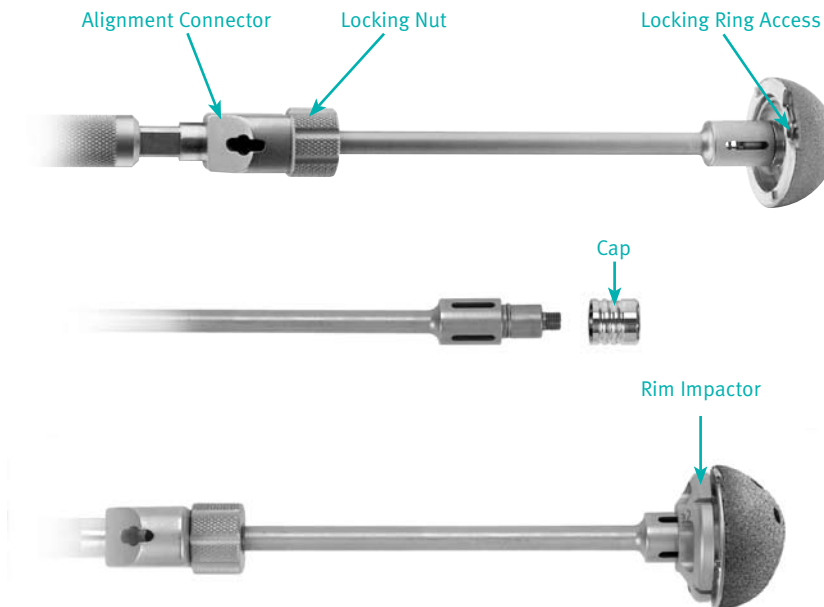

## Implant Positioning and Alignment

Ensure the patient is in the correct position. With the final prosthesis connected to the Acetabular Cup Impactor/Positioner, insert shell into the prepared site. Keep the slap hammer portion of the positioner vertical, and "A-Frame" or "Gunsight" extension parallel with the patient's body, to achieve 45 degrees abduction and 20 degrees forward flexion.

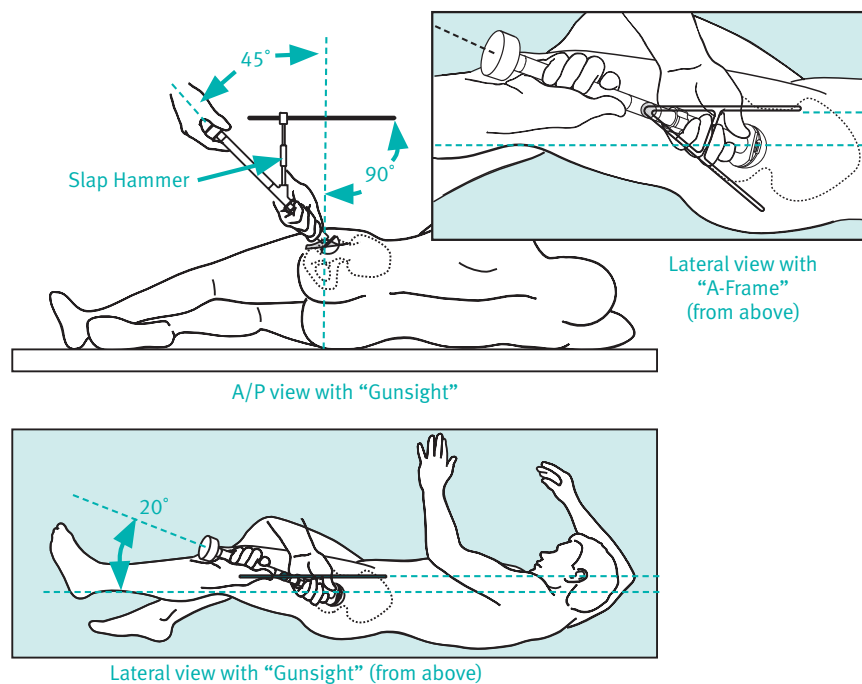

## Implant Orientation

The potential for neurologic and vascular injury can be minimized if the posterior quadrants are used for trans-acetabular screw placement.\* The cluster-holed shell should be positioned to allow screw placement in the posterior superior and/or posterior inferior quadrants of the acetabulum.

\* Wasielewski RC, Cooperstein LA, Kruger MP, Rubash HE. Acetabular anatomy and the transacetabular fixation of screws in total hip arthroplasty. *J Bone Joint Surg.* 1990;72-A,4,501-508.

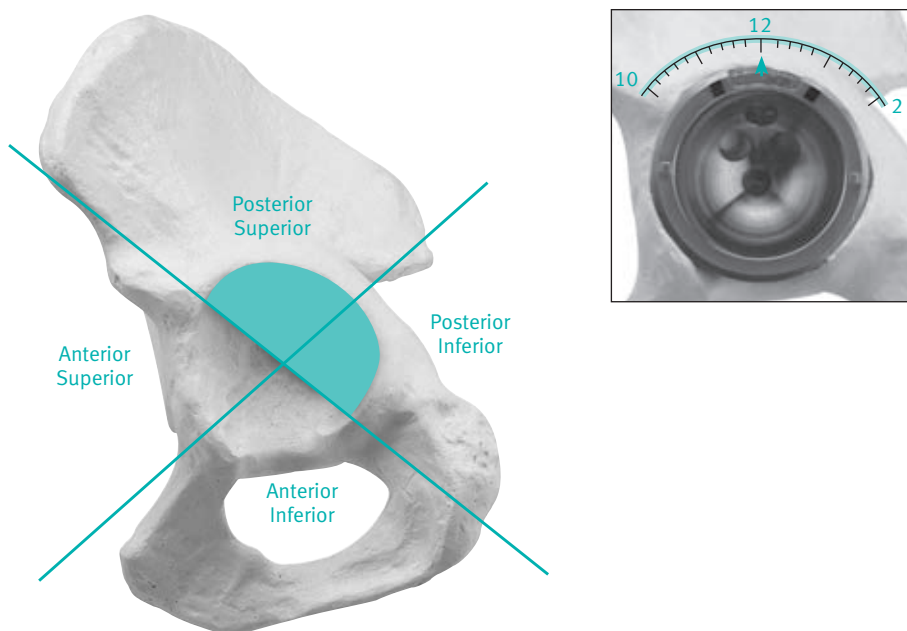

## Implant Insertion

The “Gunsight” or “A-Frame” Alignment Guides can be used to aid in cup positioning. Use short strikes with a small mallet to impact the cup. The impact required to safely seat the implant is dictated by the bone quality. Due to impaction, it may be necessary to periodically re-tighten the collet or locking nut. Remove the “A-Frame” or “Gunsight” device during continued impaction. Use screw holes to determine if the shell is fully seated.



Optional Offset Shell Inserters  
00-7804-025-20

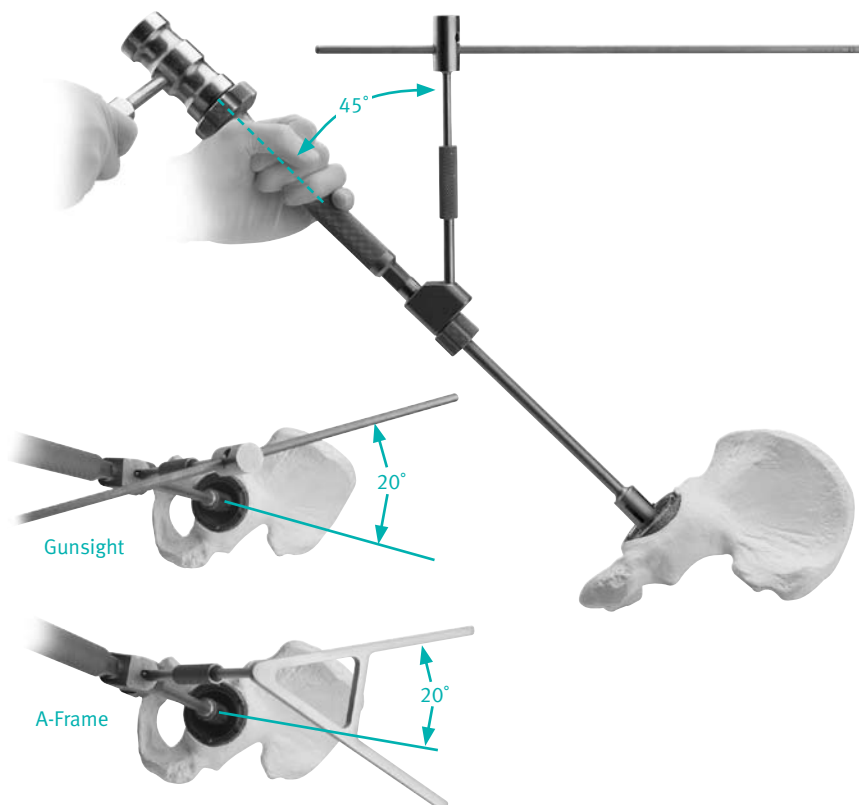

## Screw Insertion

If screw placement is desired, drill a pilot hole by placing the drill through the Drill Guide in the desired screw hole (A). Measure the hole's depth with the Depth Gauge (B).

Before inserting screws, attach the Torque Limiter to the Screwdriver (C). Avoid overtightening of screws and potential advancement through the shell screw hole. **Note:** The Torque Limiter does not eliminate the need for surgeon evaluation of bone quality, appropriate screw selection, and torque control.

Select the appropriate length screw and insert it in the hole with the Screwdriver (D). Place additional screws as necessary.

**Warning: Avoid screw placement through the shell into the anterior inferior quadrant of the acetabulum to prevent injury to the neuro-vascular structures.**

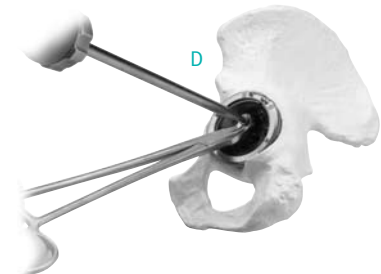
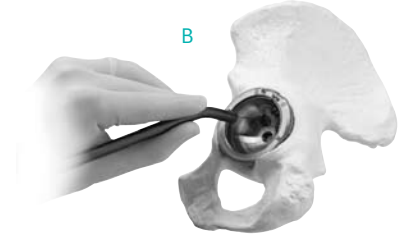
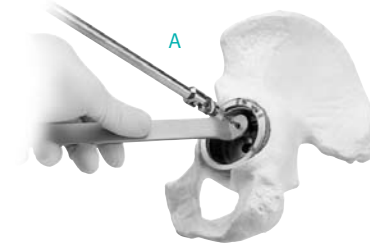

## Liner Positioning

Insert Provisional Liner into prosthesis to check appropriate liner elevation. The anti-rotational slots on the trial liner should line up with the two anti-rotational tabs and black etch marks located on the rim of the shell. Clear all soft tissue from around the perimeter of the shell and assess visualization. To achieve complete congruency, dry inner shell thoroughly. Place the final poly liner with Liner Positioner, or by hand. Align with anti-rotational tabs. Ensure that both tabs are engaged with prosthesis liner slots.

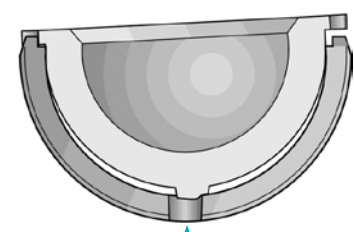
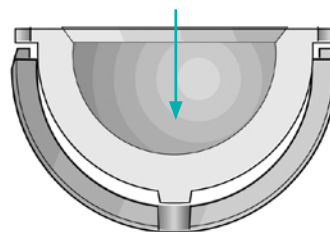
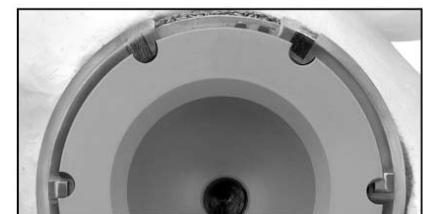
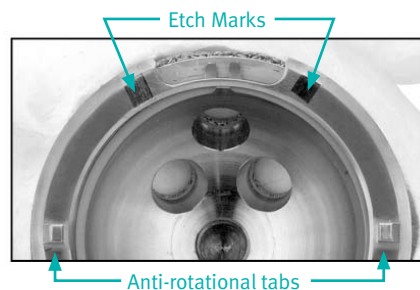

## Liner Insertion

Push the liner into the shell. Impaction may be necessary to fully engage liner into shell. Watch for the locking tabs to open and then close together. There will be a 2mm to 3mm gap between the locking ring tabs. The prosthetic liner is fully seated when the locking ring tabs can be moved from side-to-side with a probe. The ring serves to lock the liner in place. It must float freely inside the shell to function properly.

A  
Before Insertion



B  
Insertion



C  
Locked



D  
Fully Seated (side-to-side check)



## Locking Ring Replacement (if required)

If upon inspection, it is determined that the locking ring is not functioning properly or has become damaged, it must be replaced. If seated, the liner is removed using the Disassembly Device to open the ring, while at the same time using the Liner Extractor to clamp and lift the liner out of the shell.

To remove the old ring, push the ring to the side of the shell and grab the exposed portion on the opposite side of the shell. A firm and steady grip is required. To insert a new ring, first insert the tabs of the ring into the locking ring window. Then, press the ring into place. When properly seated, the ring will first pop into place and then float freely in the shell. Liner assembly can now take place.

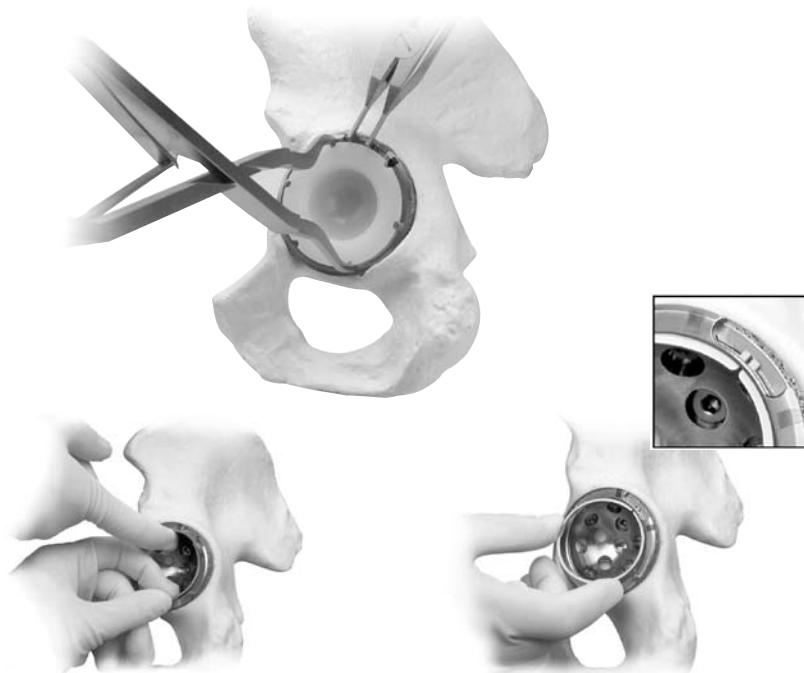

## Final Reduction

Perform final reduction to assess range of motion, hip stability, and limb length. If “fine tuning” or a different liner style is needed, use the Disassembly Device to remove the liner.



## Ordering Information

### Trabecular Metal Acetabular Shells

SHELLS are available in 2mm OD increments  
6202-SHELL OD-SHELL TYPE

Cat. No.	Description
<b>Non-Holed</b>	
00-6202-038-21	Trabecular Metal Acetabular Shell, 38mm, Solid Through ↓ Through ↓
00-6202-070-21	Trabecular Metal Acetabular Shell, 70mm, Solid
<b>Cluster-Holed</b>	
00-6202-038-22	Trabecular Metal Acetabular Shell, 38mm, Cluster Through ↓ Through ↓
00-6202-080-22	Trabecular Metal Acetabular Shell, 80mm, Cluster
<b>Multi-Holed</b>	
00-6202-038-20	Trabecular Metal Acetabular Shell, 38mm, Multi Through ↓ Through ↓
00-6202-080-20	Trabecular Metal Acetabular Shell, 80mm, Multi

### Bone Screws

SCREWS are available in 5mm LENGTH increments up to 40mm 6250-SIZE-LENGTH

Cat. No.	Description
00-6250-045-15	Bone Screw, 4.5x15mm, Self-Tapping Through ↓ Through ↓
00-6250-045-40	Bone Screw, 4.5x40mm, Self-Tapping
00-6250-045-50	Bone Screw, 4.5x50mm, Self-Tapping
00-6250-045-60	Bone Screw, 4.5x60mm, Self-Tapping
00-6250-065-15	Bone Screw, 6.5x15mm, Self-Tapping Through ↓ Through ↓
00-6250-065-40	Bone Screw, 6.5x40mm, Self-Tapping
00-6250-065-50	Bone Screw, 6.5x50mm, Self-Tapping
00-6250-065-60	Bone Screw, 6.5x60mm, Self-Tapping
00-6250-065-70	Bone Screw, 6.5x70mm, Self-Tapping
00-6250-065-80	Bone Screw, 6.5x80mm, Self-Tapping

**Warning:** This device is not approved for screw attachment or fixation to the posterior elements (pedicles) of the cervical, thoracic, or lumbar spine.

### Polyethylene Liner Thickness

Shell OD (mm)	Polyethylene Liner					
	22mm	26mm	28mm	32mm	36mm	40mm
38	5.1	—	—	—	—	—
40	6.1	—	—	—	—	—
42	6.1	5.3	—	—	—	—
44	7.1	6.2	5.2	—	—	—
46	8.2	6.3	6.3	—	—	—
48	9.1	7.3	6.2	5.3	—	—
50	10.1	8.2	7.2	6.3	6.8	—
52	10.1	8.2	7.2	6.3	6.8	—
54	10.1	8.2	7.2	6.3	6.8	—
56	11.2	9.3	8.3	6.4	7.9	—
58	12.2	10.3	9.3	7.3	8.9	6.8
60	13.2	11.3	10.3	8.4	9.9	7.9
62	14.2	12.3	11.3	9.3	10.9	8.9
64	15.2	13.3	12.3	10.3	11.9	9.9
66	16.2	14.3	13.3	11.4	12.9	10.9
68	17.2	15.4	14.3	12.4	13.9	11.9
70	18.2	16.3	15.3	13.3	14.9	12.9
72	19.2	17.3	16.3	14.4	15.9	13.9
74	20.2	18.4	17.3	15.4	16.9	14.9
76	21.2	19.3	18.3	16.3	17.9	15.9
78	22.2	20.3	19.3	17.3	18.9	16.9
80	23.2	21.3	20.3	18.3	19.9	17.9

### Longevity® Highly Crosslinked Polyethylene Liners

Liners are available in 2mm increments  
Shell sizes 50, 52, and 54 use the same size liner.

Cat. No.	Description
<b>Neutral</b>	
00-6305-036-22	Poly Liner, 36mm OD x 22mm ID Through ↓ Through ↓
00-6305-080-22	Poly Liner, 80mm OD x 22mm ID
00-6305-042-26	Poly Liner, 42mm OD x 26mm ID Through ↓ Through ↓
00-6305-080-26	Poly Liner, 80mm OD x 26mm ID
00-6305-044-28	Poly Liner, 44mm OD x 28mm ID Through ↓ Through ↓
00-6305-080-28	Poly Liner, 80mm OD x 28mm ID
00-6305-048-32	Poly Liner, 48mm OD x 32mm ID Through ↓ Through ↓
00-6305-080-32	Poly Liner, 80mm OD x 32mm ID
00-6305-050-36	Poly Liner, 50mm OD x 36mm ID Through ↓ Through ↓
00-6305-080-36	Poly Liner, 80mm OD x 36mm ID
00-6305-058-40	Poly Liner, 58mm OD x 40mm ID Through ↓ Through ↓
00-6305-080-40	Poly Liner, 80mm OD x 40mm ID

### Longevity Crosslinked Polyethylene Liners

Liners are available in 2mm increments  
Shell sizes 50, 52, and 54 use the same size liner.

Cat. No.	Description
<b>10° Elevated</b>	
00-6310-036-22	10° Elevated Rim Liner, 36mm OD x 22mm ID Through ↓ Through ↓
00-6310-080-22	10° Elevated Rim Liner, 80mm OD x 22mm ID
00-6310-042-26	10° Elevated Rim Liner, 42mm OD x 26mm ID Through ↓ Through ↓
00-6310-080-26	10° Elevated Rim Liner, 80mm OD x 26mm ID
00-6310-044-28	10° Elevated Rim Liner, 44mm OD x 28mm ID Through ↓ Through ↓
00-6310-080-28	10° Elevated Rim Liner, 80mm OD x 28mm ID
00-6310-048-32	10° Elevated Rim Liner, 48mm OD x 32mm ID Through ↓ Through ↓
00-6310-080-32	10° Elevated Rim Liner, 80mm OD x 32mm ID
00-6310-058-36	10° Elevated Rim Liner, 58mm OD x 36mm ID Through ↓ Through ↓
00-6310-080-36	10° Elevated Rim Liner, 80mm OD x 36mm ID
<b>20° Elevated</b>	
00-6320-036-22	20° Elevated Rim Liner, 36mm OD x 22mm ID Through ↓ Through ↓
00-6320-080-22	20° Elevated Rim Liner, 80mm OD x 22mm ID
00-6320-042-26	20° Elevated Rim Liner, 42mm OD x 26mm ID Through ↓ Through ↓
00-6320-080-26	20° Elevated Rim Liner, 80mm OD x 26mm ID
00-6320-044-28	20° Elevated Rim Liner, 44mm OD x 28mm ID Through ↓ Through ↓
00-6320-080-28	20° Elevated Rim Liner, 80mm OD x 28mm ID
00-6320-048-32	20° Elevated Rim Liner, 48mm OD x 32mm ID Through ↓ Through ↓
00-6320-080-32	20° Elevated Rim Liner, 80mm OD x 32mm ID
<b>7mm Offset</b>	
00-6341-040-22	7mm Offset, 40mm OD x 22mm ID Through ↓ Through ↓
00-6341-070-22	7mm Offset, 70mm OD x 22mm ID
00-6341-042-26	7mm Offset, 42mm OD x 26mm ID Through ↓ Through ↓
00-6341-070-26	7mm Offset, 70mm OD x 26mm ID
00-6341-044-28	7mm Offset, 44mm OD x 28mm ID Through ↓ Through ↓
00-6341-070-28	7mm Offset, 70mm OD x 28mm ID
00-6341-048-32	7mm Offset, 48mm OD x 32mm ID Through ↓ Through ↓
00-6341-070-32	7mm Offset, 70mm OD x 32mm ID

For more information on the *Trilogy Longevity* Constrained Liners and Instrumentation, refer to the Surgical Technique Lit # 97-6334-002-00.

## Polyethylene Liners

Liners are available in 2mm increments  
Shell sizes 50, 52, and 54 use the same size liner.

Cat. No.	Description
<b>Neutral</b>	
00-6105-036-22	Poly Liner, 36mm OD x 22mm ID
Through ↓	Through ↓
00-6105-080-22	Poly Liner, 80mm OD x 22mm ID
00-6105-042-26	Poly Liner, 42mm OD x 26mm ID
Through ↓	Through ↓
00-6105-080-26	Poly Liner, 80mm OD x 26mm ID
00-6105-044-28	Poly Liner, 44mm OD x 28mm ID
Through ↓	Through ↓
00-6105-080-28	Poly Liner, 80mm OD x 28mm ID
00-6105-048-32	Poly Liner, 48mm OD x 32mm ID
Through ↓	Through ↓
00-6105-080-32	Poly Liner, 80mm OD x 32mm ID
<b>10° Elevated</b>	
00-6110-036-22	10° Elevated Rim Liner, 36mm OD x 22mm ID
Through ↓	Through ↓
00-6110-080-22	10° Elevated Rim Liner, 80mm OD x 22mm ID
00-6110-042-26	10° Elevated Rim Liner, 42mm OD x 26mm ID
Through ↓	Through ↓
00-6110-080-26	10° Elevated Rim Liner, 80mm OD x 26mm ID
00-6110-044-28	10° Elevated Rim Liner, 44mm OD x 28mm ID
Through ↓	Through ↓
00-6110-080-28	10° Elevated Rim Liner, 80mm OD x 28mm ID
00-6110-048-32	10° Elevated Rim Liner, 48mm OD x 32mm ID
Through ↓	Through ↓
00-6110-080-32	10° Elevated Rim Liner, 80mm OD x 32mm ID
<b>20° Elevated</b>	
00-6120-036-22	20° Elevated Rim Liner, 36mm OD x 22mm ID
Through ↓	Through ↓
00-6120-080-22	20° Elevated Rim Liner, 80mm OD x 22mm ID
00-6120-042-26	20° Elevated Rim Liner, 42mm OD x 26mm ID
Through ↓	Through ↓
00-6120-080-26	20° Elevated Rim Liner, 80mm OD x 26mm ID
00-6120-044-28	20° Elevated Rim Liner, 44mm OD x 28mm ID
Through ↓	Through ↓
00-6120-080-28	20° Elevated Rim Liner, 80mm OD x 28mm ID
00-6120-048-32	20° Elevated Rim Liner, 48mm OD x 32mm ID
Through ↓	Through ↓
00-6120-080-32	20° Elevated Rim Liner, 80mm OD x 32mm ID

## Polyethylene Liners

Liners are available in 2mm increments  
Shell sizes 50, 52, and 54 use the same size liner.

Cat. No.	Description
<b>7mm Offset</b>	
00-6141-040-22	7mm Offset, 40mm OD x 22mm ID
Through ↓	Through ↓
00-6141-070-22	7mm Offset, 70mm OD x 22mm ID
00-6141-042-26	7mm Offset, 42mm OD x 26mm ID
Through ↓	Through ↓
00-6141-070-26	7mm Offset, 70mm OD x 26mm ID
00-6141-044-28	7mm Offset, 44mm OD x 28mm ID
Through ↓	Through ↓
00-6141-070-28	7mm Offset, 70mm OD x 28mm ID
00-6141-048-32	7mm Offset, 48mm OD x 32mm ID
Through ↓	Through ↓
00-6141-070-32	7mm Offset, 70mm OD x 32mm ID
<b>Eccentric</b>	
00-6151-000-28	Eccentric Liner Set (Includes all 28mm ID liners listed below)
00-6151-064-28	Eccentric Liner, 64mm OD x 28mm ID
Through ↓	Through ↓
00-6151-080-28	Eccentric Liner, 80mm OD x 28mm ID
00-6151-000-32	Eccentric Liner Set (Includes all 32mm ID liners listed below)
00-6151-064-32	Eccentric Liner, 64mm OD x 32mm ID
Through ↓	Through ↓
00-6151-080-32	Eccentric Liner, 80mm OD x 32mm ID
<b>Oblique</b>	
00-6152-000-01	Oblique Liner Set (Includes all 22mm liners listed below)
00-6152-038-22	Oblique Liner, 38mm OD x 22mm ID
Through ↓	Through ↓
00-6152-048-22	Oblique Liner, 48mm OD x 22mm ID
00-6152-000-02	Oblique Liner Set (Includes all 28mm liners listed below)
00-6152-050-28	Oblique Liner, 50mm OD x 28mm ID
Through ↓	Through ↓
00-6152-062-28	Oblique Liner, 62mm OD x 28mm ID
00-6152-000-03	Oblique Liner Set (Includes all 32mm liners listed below)
00-6152-056-32	Oblique Liner, 56mm OD x 32mm ID
Through ↓	Through ↓
00-6152-062-32	Oblique Liner, 62mm OD x 32mm ID

## Liner Provisionals

Liner Provisionals are available in 2mm increments. Shell sizes 50, 52, and 54 use the same size provisional liner. Locking Screws are ordered separately.

### Polar Screws (Optional)

Cat. No.	Description
00-6270-099-10	Polar Screw Set (Includes seven each of item below)
00-6270-001-00	Polar Screw

### Liner Provisionals 22mm

Cat. No.	Description
00-6270-099-22	Neutral Provisional Liner Set - 22mm (Includes one each of items below)
00-6270-040-22	Neutral Provisional Liner, 22mm
Through ↓	Through ↓
00-6270-070-22	Neutral Provisional Liner, 22mm
00-6271-099-22	10° Elev. Provisional Liner Set - 22mm (Includes one each of items below)
00-6271-040-22	10° Elev. Provisional Liner, 22mm
Through ↓	Through ↓
00-6271-070-22	10° Elev. Provisional Liner, 22mm
00-6272-099-22	20° Elev. Provisional Liner Set - 22mm (Includes one each of items below)
00-6272-040-22	20° Elev. Provisional Liner, 22mm
Through ↓	Through ↓
00-6272-070-22	20° Elev. Provisional Liner, 22mm
00-6270-199-22	Neutral Jumbo Provisional Liner Set - 22mm (Includes one each of items below)
00-6270-072-22	Neutral Jumbo Provisional Liner, 22mm
Through ↓	Through ↓
00-6270-080-22	Neutral Jumbo Provisional Liner, 22mm
00-6271-199-22	10° Elev. Jumbo Provisional Liner Set - 22mm (Includes one each of items below)
00-6271-072-22	10° Elev. Jumbo Provisional Liner, 22mm
Through ↓	Through ↓
00-6271-080-22	10° Jumbo Provisional Liner, 22mm
00-6272-199-22	20° Elev. Jumbo Provisional Liner Set - 22mm (Includes one each of items below)
00-6272-072-22	20° Elev. Provisional Liner, 22mm
Through ↓	Through ↓
00-6272-080-22	20° Elev. Provisional Liner, 22mm

**Liner Provisionals 26mm**

Cat. No.	Description
00-6270-099-26	Neutral Provisional Liner Set - 26mm (Includes one each of items below)
00-6270-042-26	Neutral Provisional Liner, 26mm
Through ↓	Through ↓
00-6270-070-26	Neutral Provisional Liner, 26mm
00-6271-099-26	10° Elev. Provisional Liner Set - 26mm (Includes one each of items below)
00-6271-042-26	10° Elev. Provisional Liner, 26mm
Through ↓	Through ↓
00-6271-070-26	10° Elev. Provisional Liner, 26mm
00-6272-099-26	20° Elev. Provisional Liner Set - 26mm (Includes one each of items below)
00-6272-042-26	20° Elev. Provisional Liner, 26mm
Through ↓	Through ↓
00-6272-070-26	20° Elev. Provisional Liner, 26mm
00-6270-199-26	Neutral Jumbo Provisional Liner Set - 26mm (Includes one each of items below)
00-6270-072-26	Neutral Jumbo Provisional Liner, 26mm
Through ↓	Through ↓
00-6270-080-26	Neutral Jumbo Provisional Liner, 26mm
00-6271-199-26	10° Elev. Jumbo Provisional Liner Set - 26mm (Includes one each of items below)
00-6271-072-26	10° Elev. Jumbo Provisional Liner, 26mm
Through ↓	Through ↓
00-6271-080-26	10° Elev. Jumbo Provisional Liner, 26mm
00-6272-199-26	20° Elev. Jumbo Provisional Liner Set - 26mm (Includes one each of items below)
00-6272-072-26	20° Elev. Jumbo Provisional Liner, 26mm
Through ↓	Through ↓
00-6272-080-26	20° Elev. Jumbo Provisional Liner, 26mm

**Liner Provisionals 28mm**

Cat. No.	Description
00-6270-099-28	Neutral Provisional Liner Set - 28mm (Includes one each of items below)
00-6270-044-28	Neutral Provisional Liner, 28mm
Through ↓	Through ↓
00-6270-070-28	Neutral Provisional Liner, 28mm
00-6271-099-28	10° Elev. Provisional Liner Set - 28mm (Includes one each of items below)
00-6271-044-28	10° Elev. Provisional Liner, 28mm
Through ↓	Through ↓
00-6271-070-28	10° Elev. Provisional Liner, 28mm
00-6272-099-28	20° Elev. Provisional Liner Set - 28mm (Includes one each of items below)
00-6272-044-28	20° Elev. Provisional Liner, 28mm
Through ↓	Through ↓
00-6272-070-28	20° Elev. Provisional Liner, 28mm

**Liner Provisionals 28mm (cont.)**

Cat. No.	Description
00-6270-199-28	Neutral Jumbo Provisional Liner Set - 28mm (Includes one each of items below)
00-6270-072-28	Neutral Jumbo Provisional Liner, 28mm
Through ↓	Through ↓
00-6270-080-28	Neutral Jumbo Provisional Liner, 28mm
00-6271-199-28	10° Elev. Jumbo Provisional Liner Set - 28mm (Includes one each of items below)
00-6271-072-28	10° Elev. Jumbo Provisional Liner, 28mm
Through ↓	Through ↓
00-6271-080-28	10° Elev. Jumbo Provisional Liner, 28mm
00-6272-199-28	20° Elev. Jumbo Provisional Liner Set - 28mm (Includes one each of items below)
00-6272-072-28	20° Elev. Jumbo Provisional Liner, 28mm
Through ↓	Through ↓
00-6272-080-28	20° Elev. Jumbo Provisional Liner, 28mm

**Liner Provisionals 32mm**

Cat. No.	Description
00-6270-099-32	Neutral Provisional Liner Set - 32mm (Includes one each of items below)
00-6270-048-32	Neutral Provisional Liner, 32mm
Through ↓	Through ↓
00-6270-070-32	Neutral Provisional Liner, 32mm
00-6271-099-32	10° Elev. Provisional Liner Set - 32mm (Includes one each of items below)
00-6271-048-32	10° Elev. Provisional Liner, 32mm
Through ↓	Through ↓
00-6271-070-32	10° Elev. Provisional Liner, 32mm
00-6272-099-32	20° Provisional Liner Set - 32mm (Includes one each of items below)
00-6272-048-32	20° Elev. Provisional Liner, 32mm
Through ↓	Through ↓
00-6272-070-32	20° Elev. Provisional Liner, 32mm
00-6270-199-32	Neutral Jumbo Provisional Liner Set - 32mm (Includes one each of items below)
00-6270-072-32	Neutral Jumbo Provisional Liner, 32mm
Through ↓	Through ↓
00-6270-080-32	Neutral Jumbo Provisional Liner, 32mm
00-6271-199-32	10° Elev. Jumbo Provisional Liner Set - 32mm (Includes one each of items below)
00-6271-072-32	10° Elev. Jumbo Provisional Liner, 32mm
Through ↓	Through ↓
00-6271-080-32	10° Elev. Jumbo Provisional Liner, 32mm
00-6272-199-32	20° Elev. Jumbo Provisional Liner Set - 32mm (Includes one each of items below)
00-6272-072-32	20° Elev. Jumbo Provisional Liner, 32mm
Through ↓	Through ↓
00-6272-080-32	20° Elev. Jumbo Provisional Liner, 32mm

**Liner Provisionals/Instruments 36mm**

Cat. No.	Description
00-6270-099-36	Neutral Provisional Liner Set - 36mm (Includes one each of items below)
00-6261-090-00	Case (Includes Base and Lid)
00-6270-050-36	Neutral Provisional Liner, 36mm
Through ↓	Through ↓
00-6270-080-36	Neutral Provisional Liner, 36mm
00-7695-036-01	6° Femoral Head Provisional
Through ↓	Through ↓
00-7695-036-05	6° Femoral Head Provisional
00-7895-036-01	12/14 Femoral Head Provisional
Through ↓	Through ↓
00-7895-036-05	12/14 Femoral Head Provisional
00-6260-017-36	Liner Inserter
00-6271-099-36	10° Elev. Provisional Liner Set - 36mm (Includes one each of items below)
00-6261-090-00	Case (Includes Base and Lid)
00-6271-058-36	10° Elev. Provisional Liner, 36mm
Through ↓	Through ↓
00-6271-080-36	10° Elev. Provisional Liner, 36mm
00-7695-036-01	6° Femoral Head Provisional
Through ↓	Through ↓
00-7695-036-05	6° Femoral Head Provisional
00-7895-036-01	12/14 Femoral Head Provisional
Through ↓	Through ↓
00-7895-036-05	12/14 Femoral Head Provisional
00-6260-017-36	Liner Inserter

**Liner Provisionals/Instruments 40mm**

Cat. No.	Description
00-6270-099-40	Neutral Instrument Set - 40mm (Includes one each of items below)
00-6270-002-00	Case (Includes Base and Lid)
00-6270-058-40	Neutral Provisional Liner, 40mm
Through ↓	Through ↓
00-6270-080-40	Neutral Provisional Liner, 40mm
00-7895-040-01	12/14 Femoral Head Provisional
Through ↓	Through ↓
00-7895-040-05	12/14 Femoral Head Provisional
00-6260-017-40	Liner Inserter

\* This set is used to convert an old instrument set to the neutral 40mm liner provisional.

**Liner Provisionals 7mm Offset**

Cat. No.	Description
00-6275-099-22	7mm Offset Provisional Liner Set - 22mm (Includes one each of items below)
00-6275-040-22	7mm Offset Provisional Liner, 22mm
Through ↓	Through ↓
00-6275-070-22	7mm Offset Provisional Liner, 22mm
00-6275-099-26	7mm Offset Provisional Liner Set - 26mm (Includes one each of items below)
00-6275-042-26	7mm Offset Provisional Liner, 26mm
Through ↓	Through ↓
00-6275-070-26	7mm Offset Provisional Liner, 26mm
00-6275-099-28	7mm Offset Provisional Liner Set - 28mm (Includes one each of items below)
00-6275-044-28	7mm Offset Provisional Liner, 28mm
Through ↓	Through ↓
00-6275-070-28	7mm Offset Provisional Liner, 28mm
00-6275-099-32	7mm Offset Provisional Liner Set - 32mm (Includes one each of items below)
00-6275-048-32	7mm Offset Provisional Liner, 32mm
Through ↓	Through ↓
00-6275-070-32	7mm Offset Provisional Liner, 32mm

**Liner Provisionals - Eccentric**

Cat. No.	Description
00-6171-099-28	Eccentric Provisional Liner Set - 28mm (Includes one each of items below)
00-6171-064-28	Eccentric Provisional Liner, 28mm
Through ↓	Through ↓
00-6161-080-28	Eccentric Provisional Liner, 28mm
00-6171-099-32	Eccentric Provisional Liner Set - 32mm (Includes one each of items below)
00-6171-064-32	Eccentric Provisional Liner, 32mm
Through ↓	Through ↓
00-6171-080-32	Eccentric Provisional Liner, 32mm
00-6260-019-00	Eccentric Liner Inserter Handle
00-6260-019-28	Eccentric Liner Inserter Head, 28mm
00-6260-019-32	Eccentric Liner Inserter Head, 32mm

**Liner Provisionals - Oblique**

Cat. No.	Description
00-6172-099-22	Oblique Provisional Liner Set - 22mm (Includes one each of items below)
00-6172-038-22	Oblique Provisional Liner, 22mm
Through ↓	Through ↓
00-6162-048-22	Oblique Provisional Liner, 22mm
00-6172-099-28	Oblique Provisional Liner Set - 28mm (Includes one each of items below)
00-6172-050-28	Oblique Provisional Liner, 28mm
Through ↓	Through ↓
00-6172-062-28	Oblique Provisional Liner, 28mm
00-6172-099-32	Oblique Provisional Liner Set - 32mm (Includes one each of items below)
00-6172-056-32	Oblique Provisional Liner, 32mm
Through ↓	Through ↓
00-6172-062-32	Oblique Provisional Liner, 32mm

**Liner Removal Instruments**

(Included in *Trilogy* Non-Holed Instrument Set, 00-6260-099-01)

Cat. No.	Description
00-6260-030-01	Disassembly Device
00-6260-035-01	Liner Extractor
00-6260-040-00	Liner Elevator

**Modular Acetabular Instrument Set**

Cat. No.	Description
00-6270-099-01	Instrument Set (Includes one each of items below)
00-6275-010-00	Case (Includes Base and Lid)
00-6260-030-01	Disassembly Device
00-6260-035-01	Liner Extractor
00-6260-040-00	Liner Elevator
00-6260-018-00	Cup Positioner
00-6260-047-00	Gunsight Alignment Guide
00-5785-079-00	Tibial Alignment Rod
00-6260-002-00	Flex Shaft w/Modular Connector
00-6260-003-01	Drill Bit, 15mm
00-6260-003-02	Drill Bit, 30mm
00-6260-003-03	Drill Bit, 45mm
00-6260-006-00	Drill Guide
00-6260-007-01	Tap, 4.5mm
00-6260-007-02	Tap, 6.5mm
00-6260-008-01	Tap Guide, 4.5mm
00-6260-008-02	Tap Guide, 6.5mm
00-6260-010-00	Tap Handle
00-6260-013-00	Screw Holding Forceps, 15"
00-6260-014-00	Screw Holding Forceps, 45"
00-6260-024-00	Straight Screwdriver
00-6260-025-00	Universal Screwdriver
00-6260-026-00	Modular Universal Handle
00-6611-098-00	Depth Gauge
00-4215-200-00	Torque Limiter

**Optional/Additional Instruments**

Cat. No.	Description
00-6260-046-00	A-Frame Alignment Guide
00-6611-003-01	Drill Bit, Short-Flexible (HGP II)
00-6611-003-02	Drill Bit, Medium-Flexible (HGP II)
00-6611-003-03	Drill Bit, Long-Flexible (HGP II)
00-6260-015-11	Replaceable Poly Cap (6 ea.)
00-6260-015-12	Replaceable Metal Cap (1 ea.)
00-6260-016-22	Liner Inserter (Vacuum)
00-6260-016-26	Liner Inserter (Vacuum)
00-6260-016-28	Liner Inserter (Vacuum)
00-6260-016-32	Liner Inserter (Vacuum)
00-6260-017-22	Liner Inserter (Mechanical)
00-6260-017-26	Liner Inserter (Mechanical)
00-6260-017-28	Liner Inserter (Mechanical)
00-6260-017-32	Liner Inserter (Mechanical)
00-6260-017-36	Liner Inserter (Mechanical)
00-6260-017-40	Liner Inserter (Mechanical)
00-6611-010-00	HGP II Cup Pusher
00-6275-019-00	Rim Impactor Tray
00-6275-025-00	Jumbo Provisional Half Case

**Acetabular Reamers**

Cat. No.	Description
00-1206-090-01	Acetabular Reamer System Standard Kit (36 - 70mm)
00-1206-090-02	Acetabular Reamer System Jumbo Kit (71 - 80mm)

**Rim Impactors**

Available in 4mm increments.

Cat. No.	Description
00-6270-099-09	Rim Impactor Set (Includes one each of items below)
00-6270-020-00	Case (Includes Base and Lid)
00-6270-038-00	Rim Impactor, 38/40mm
Through ↓	Through ↓
00-6270-078-00	Rim Impactor, 78/80mm

**Shell Provisionals**

Cat. No.	Description
00-6270-099-02	Shell Provisional Set (Includes one each of items below)
00-6275-015-00	Case (Includes Base and Lid)
00-6242-040-00	Shell Provisional, 40mm
Through ↓	Through ↓
00-6242-070-00	Shell Provisional, 70mm
00-6270-199-02	Jumbo Shell Provisional Set (Includes one each of items below)
00-6275-018-00	Tray
00-6242-072-00	Shell Provisional, 72mm
Through ↓	Through ↓
00-6242-080-00	Shell Provisional, 80mm



Please refer to package insert for complete product information, including contraindications, warnings, precautions, and adverse effects.

Contact your Zimmer Representative or visit us at [www.zimmer.com](http://www.zimmer.com)

